

2 x Multi-Kore LED Pendant

NEW

BUZZISQUARE IP20
Acoustic Shade
MKA-2 Pendant

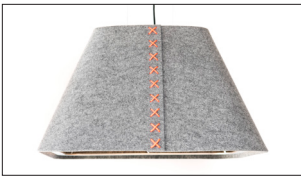

Catalog Example: MKA-P-2-KAQP-SPG-AL-C-IDH-ALS/SSSAC-LED-120/277V-DHO-DM-0-10V-AS-SQ-M-BFJE-WH-LWH-FL-M-16

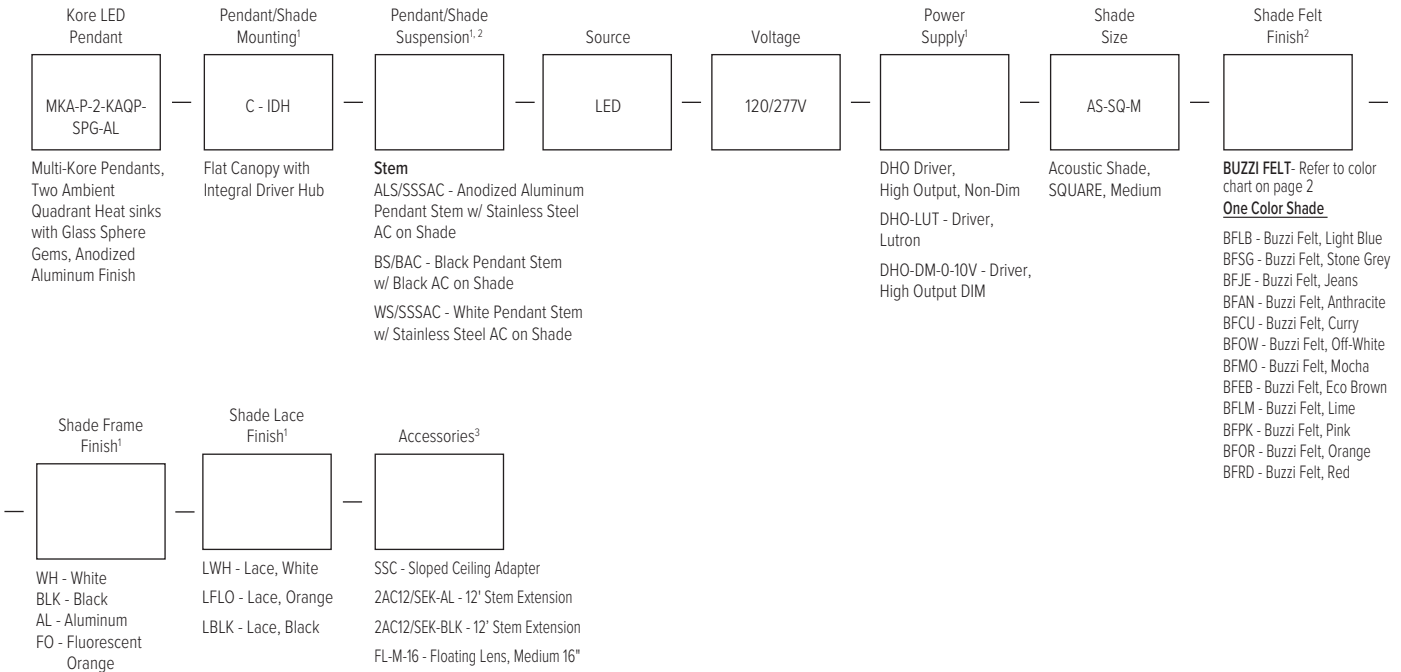

Notes:
¹ Select one.
² Tegan LED Pendant and the SQUARE Shade are not structurally attached.
³ SQUARE Pendant Stem Extension ASSY is 12' - 0" maximum. Contact Factory for longer lengths.

Kore Ambient - Drivers

Description	Tegan Power Supply Catalog #	Voltage	Dimming	Typical Driver Link ^{1,2,3}
Kore Quadrant - LED - High Output Driver	DHO	120/277V	Non-DM	Thomas LED40W-045-C0900-M-D
Kore Quadrant - LED - High Output Driver - Lutron	DHO-LUT	120/277V	Non-DM/DM	Lutron L3DA4U1UKS
Kore Quadrant - LED - High Output Dimming Driver - 0-10V	DHO-DM-0-10V	120/277V	DM	Thomas LED40W-045-C0900-M-D

Notes:
¹ Refer to manufacturer's spec sheets for compatible controls and additional detail.
² Due to the rapidly evolving technology for Semiconductor products, Tegan driver options are subject to change at any time, without notice. In addition, if any of the standard drivers are out of stock or discontinued, Tegan Lighting will supply an equal as needed. Tegan can also supply alternative drivers upon request; contact the factory for details.
³ Tegan LED emitters, like all LEDs, undergo a natural depreciation in lumen output. This depreciation is within the specifications of LM-80. Extreme ambient temperatures, dusty environments, and power conditions may affect the depreciation. Wattage requirements and lumen output are subject to change with ongoing developments in LED technology.



2 x Multi-Kore LED Pendant

Kore LED Ambient - Medium Acoustic BUZZISQUARE

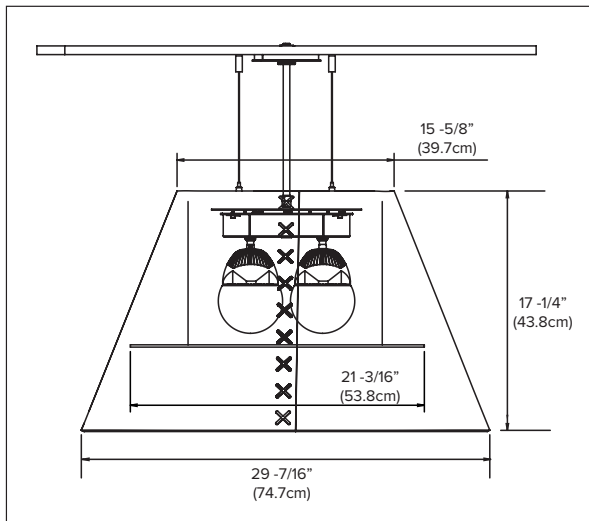

Elevation View

Multi-Kore Assembly Pendant with Two Kore LED Ambient Quadrants with Glass Sphere Gems, Stem, Medium Acoustic BUZZISQUARE.

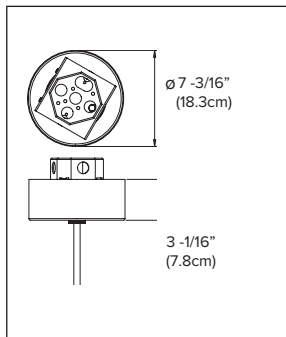

Kore Ambient Surface Mount Driver Enclosure (SMDE).

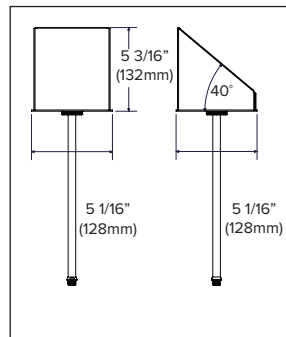

Kore Ambient Pendant - Sloped Ceiling Canopy (SCC); Elevation (left) and Section (right) views.

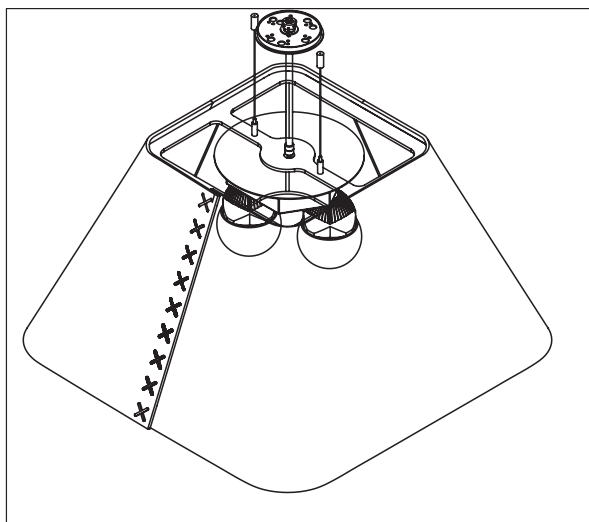

Elevation View

Multi-Kore Assembly with Two Kore LED Ambient Quadrants with Glass Sphere Gems, Stem, Medium Acoustic BUZZISQUARE with an optional Floating Lens (FL-M-16) provided with 8' (2.4m) aircraft cables, adjustable on site.

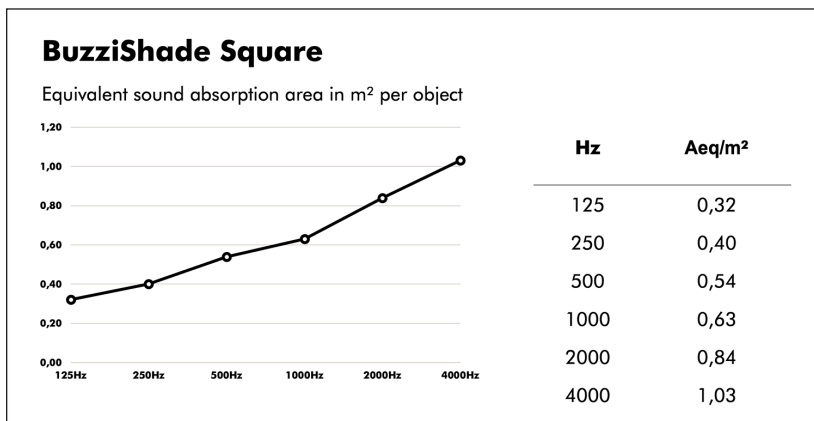

2 x Multi-Kore LED Pendant

Acoustic Shade - BUZZIFELT Finish Options*



Light Blue
(BFLB)



Stone Grey
(BFSG)

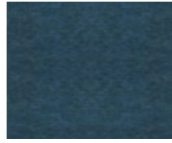

Jeans
(BFJE)

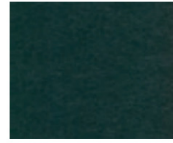

Anthracite
(BFAN)



Curry
(BFCU)

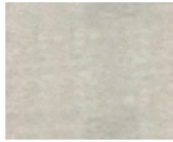

Off-White
(BFWO)

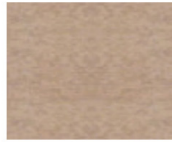

Mocha
(BFMO)

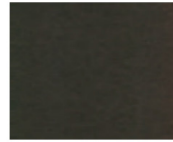

EcoBrown
(BFEB)



Lime
(BFLM)

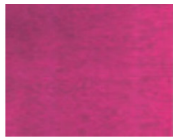

Pink
(BFPK)



Orange
(BFOR)



Red
(BFRD)

* Due to the process of thermoforming colors may vary slightly.



2 x Multi-Kore LED Pendant



Category: Tegan Lighting has teamed up with BUZZISPACE to offer Medium Acoustic BUZZISQUARE with a two (2) Multi-Kore Assembly (MKA) Pendant. The MKA features seam-less integration of two (2) High Output Kore Ambient Quadrant heat sinks with hand-blown glass Sphere Gems for uniform illumination.

The iconic shade is now reinterpreted with a twist. The BUZZISQUARE Shade consists of “eco felt” material made of 100% upcycled plastic bottles - good for the environment because it reduces waste. The felt shade material is sound absorbent, as well as being ecologically sound! BUZZISQUARE is a pendant with meticulous craftsmanship with acoustic capabilities and reduces external noise level to a maximum while blending with the interior.

Material: **Kore Pendant:**
Aluminum and steel heat sink Acrylic Frosted Cylinder Gem. Aluminum and steel canopy with aluminum single stem suspension.

Acoustic Shade Material:

BUZZI FELT - 100% Recycled P.E.T. felt from plastic bottle waste with an acrylic backing.

Shade Frame: Powdercoat finish White, Orange and Black on Aluminum, Brushed Unfinished Aluminum. No special order colors on Frame.

Shade “Lace”: Black, White or Fluorescent Orange; cotton blend. Contact factory for Red Lace. No special order colors on Lace.

Shade AC Suspension Cable: Stainless Steel; Black (BLK) or Aluminum (AL) finish.

Kore Ambient Pendant: Multi-Kore Assembly Pendant with two (2) Ambient Quadrant Heat Sinks and Hand Blown Glass Sphere Gems (MKA-P-2-KAQP-SPG-AL).

Suspension/Mounting: **MKA:** Flat Canopy with Integral Driver Hub (C-IDH) with field-cutttable 6' (2m) Stem with swivel canopy that will accommodates up to 35° (total.)

BUZZISQUARE

Shade: Acoustic SQUARE shade with four frame finishes, three lace colors and twelve standard felt shade colors. BUZZISQUARE Shade 17.32” (44cm) Height X 29.53” (75cm) Width X 29.53” (75Xcm) Depth.

Shade Finish:

Shade -

BUZZI FELT: See page 3, Fabric Finish Options for details.

Shade Lace: Black, White or Fluorescent Orange. Contact factory for Red Lace.

Shade Frame: Powdercoat finish White, Orange and Black on Aluminum, Brushed Unfinished Aluminum.

BUZZISQUARE Shades are artistic and are made to order. As a result, there may be minor variations in pattern and color shade-to-shade within the same order. No two are exactly alike and they may vary slightly from lot-to-lot.

Shade Designer:

Tegan has teamed up with an international company based in Belgium, [BUZZI SPACE](#), to utilize its **acoustic shades** with our Kore Ambient LED Pendants. BUZZISQUARE is the culmination of an artistic collaboration between BUZZI SPACE and Stal Collectief; a Belgium design firm of four young furniture designers: Len de Paepe, Bob Segers, Tim Vranken, and Jonas Blondeel.

Source:

Two (2) Multi-Kore Assembly: Two (2) LED High Output - 35W @ 2100 Lumens (ea). 80-85. CRI typical. All values are initial lumens. For exact lumen output and wattage consumption data, please consult LM79 reports. Online power consumption does not include driver losses. Contact factory for 3500K, 4000K or 90 CRI.

Optics:

Refer to [Photometric](#) Report for details.

Power Supply:

High Output Non-Dimming Driver 120/277V (DHO), High Output Dimming Driver 0-10V 120/277V (DHO-DM-0-10V), High Output Non-Dimming/Dimming Driver - Lutron 120/277V (DHO-LUT). Refer to Driver table on page 1 for details.



2 x Multi-Kore LED Pendant

BUZZISQUARE IP20
Acoustic Shade
MKA-2 Pendant

Installation: MKA-P-2 (Medium Shade): J-Box to be rated for 150lbs and tied to building structure.
Acoustic Shade: Shade mounts with 6.5' (2m) field-cutttable aircraft cable to the ceiling and is not structurally connected to the MKA Pendant. Contractor to install shade to a reinforced ceiling to support the shade weight - 15.43 lbs. (6.9kg). Shade includes two (2) fasteners and two (2) fixation M6 hardware. Ceiling screws not included. Refer to Installation Sheet for more details.

Accessories: Frosted Acrylic Lens - 16" Dia. Medium (FL-M-16), AC/Stem Extension Kit with 2 - 12' (3.6m) Aircraft Cables for Shade & 12' Stem for Pendant Suspension in Black, White or Stainless Steel Finish (2AC12/SEK-AL, WH or BLK), Slope Ceiling Canopy (SSC).

Fabric Tech: BUZZI FELT: EN 13501-1 +A1: 2009; ASTM E84 Class B certified; BS476 Part 6 and 7 Class 0; CE certificated.

Care: Vacuum regularly to keep clean. Do not wash. Do not remove fabric from frame. Treat stains immediately; professional dry cleaning or blot with a clean soft damp cloth and a PH neutral soap.

Labels: CSA listed – Tested to USA UL/ANSI standards #8750 and #1598 and Canadian standards CSA C22.2, # 250.0-08 & #250.13-12. Interior applications only. LM79/80. In a continuing effort to offer the best product possible we reserve the right to change, without notice, specifications or materials. Technical specification sheets that appear on teganlighting.com are the most recent version and supersede all other versions that exist in any other printed or electronic form. 3 Year Warranty for Tegan Lighting components. 2 Year warranty for BUZZISQUARE.

