

SNAP SYSTEM ACCESSORIES

SMALL (2")

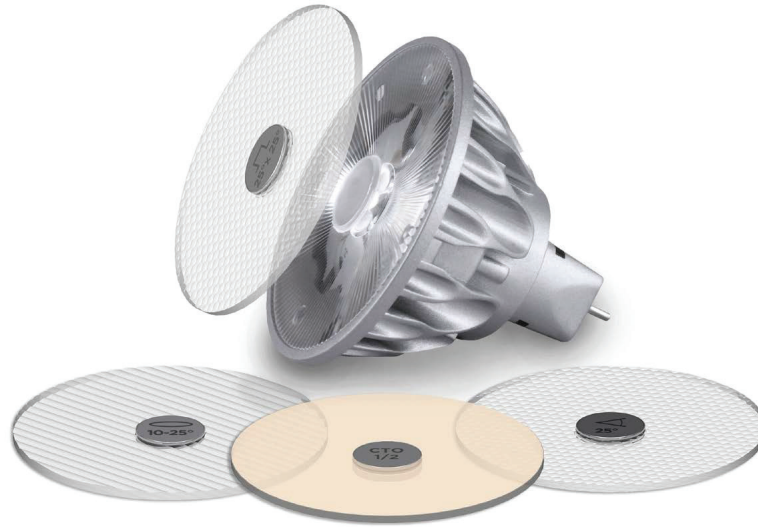

DESCRIPTION

The award winning Soraa SNAP SYSTEM™ is the first LED lamp/accessory solution that is optimized to work as an integrated system. Based on high brightness single source GaN on GaN™ LED technology, it completely redefines accessory application. The effects that can be achieved are similar to what can be done with halogen sources, but are enabled by a relatively low operating temperature and ground-breaking optical design, materials, and methods of attachment.

STACKING ACCESSORIES

SNAP SYSTEM accessories can be stacked in combination. For example, a beam spreader can be used in combination with CCT shifter. When combining the beam shaping Snap accessory with CCT shifting Snap Accessory, for best results always place CCT shifting Snap on the lamp first, as shown in diagram below.

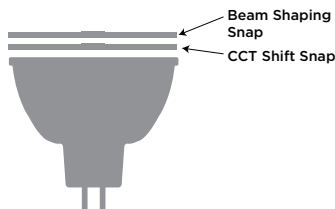

ATTACHMENT

The SNAP SYSTEM's self-centering magnetic interconnect system makes using accessories completely user friendly. Simply attached the SNAP SYSTEM accessory directly to any Narrow Spot Soraa lamp, the magnetic force from both the accessory and lamp will securely attached to one another and center itself.

COMPATIBILITY

The SNAP SYSTEM accessories Small (2") are compatible with the lamps and Optical Light Engines outlined below. The SNAP SYSTEM are only compatible with SORAA Narrow Spot lamps and Optical Light Engines. See each accessory data for exact diameter.

Small (2")
MR16
GU10
PAR20
OLE/C 16

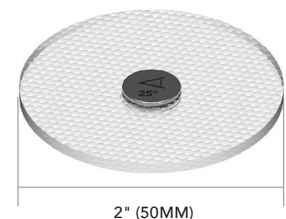

PHOTOMETRICS

IES files of accessories is available for download at http://www.soraa.com/products/snap_system

SORAA SNAP SYSTEM LED ACCESSORIES - SMALL (2")

BEAM SPREADER SNAP

Use in any application where reducing the number of beam angle SKUs is required. Reduces inventory costs. Shortens specification, design, sales cycles. Provides maximum flexibility up to the time of installation.

Beam	Part Number	Product Code	CBCP of 10° Lamp	Field Angle
17°	AC-GC-1717-00-S1	03263	30%	33°
25°	AC-GC-2525-00-S1	00325	29%	40°
36°	AC-GC-3636-00-S1	00327	14%	55°
60°	AC-GC-6060-00-S1	00329	5%	103°

Lumen Transmissivity: 90%

Diameter: 50.0 mm Thickness: 2 mm

Magnetic Attach Force: 0.45 lb-F

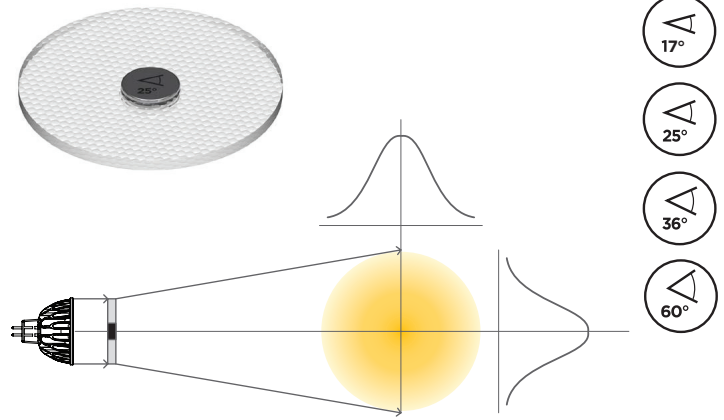

LINEAR SNAP

Use in wall washes and illuminating asymmetric objects. Reduces required number of light fixtures and spill illumination of target objects.

Beam	Part Number	Product Code	CBCP of 10° Lamp	Field Angle Horiz.	Field Angle Vert.
10° - 25°	AC-GE-1025-00-S1	00331	52%	27°	35°
10° - 36°	AC-GE-1036-00-S1	00333	38%	27°	43°
10° - 60°	AC-GE-1060-00-S1	03259	25%	25°	70°

Lumen Transmissivity: 90%

Diameter: 50.0 mm Thickness: 2 mm

Magnetic Attach Force: 0.45 lb-F

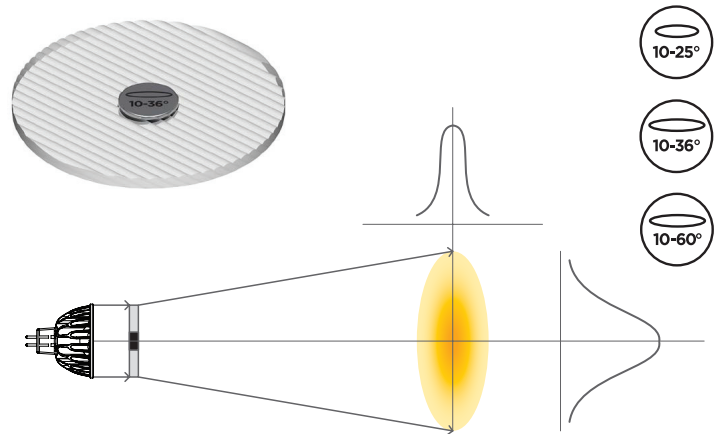

FLAT TOP SNAP

Provides even illumination center to edge. Eliminates video camera saturation, for use in applications such as critical video surveillance.

Beam	Part Number	Product Code	CBCP of 10° Lamp	Field Angle Horiz.	Field Angle Vert.
25° x 25°	AC-FR-2525-00-S1	00335	19%	44°	44°
36° x 36°	AC-FR-3636-00-S1	00337	14%	46°	46°

Lumen Transmissivity: 90%

Diameter: 50.0 mm Thickness: 2 mm

Magnetic Attach Force: 0.45 lb-F

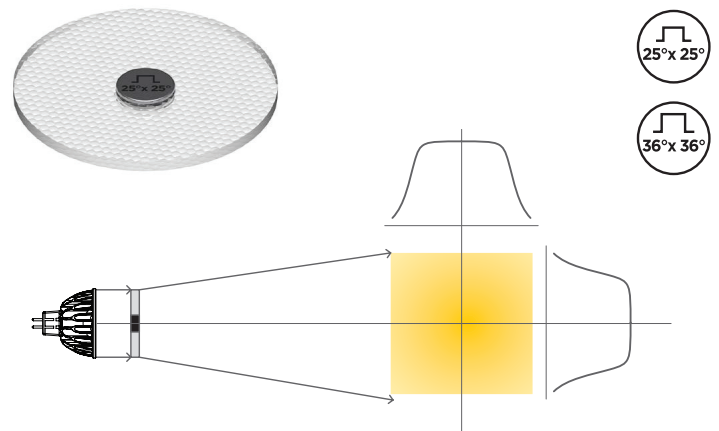

SORAA SNAP SYSTEM LED ACCESSORIES - SMALL (2")

LOUVER SNAP

Eliminates high angle glare, making light beams disappear in downlight applications.

Cutoff Angle	Part Number	Product Code	CBCP of 10° Lamp
40°	AC-LU-4040-00-S1	00339	63%

Diameter: 51.1 mm Thickness: 9.0 mm
 Magnetic Attach Force: 0.45 lb-F
 Reduces angular intensity to 0.1% of peak at 40° full angle.
 Fits around lamp face. Can be used in combination with gimbal ring fixtures.

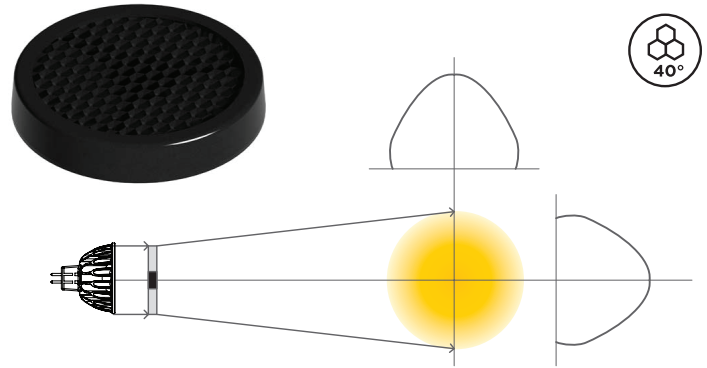

AIM SNAP

Designed with two lenses the Aim Snap bends the beam from 0 degree to maximum deflection angle of 20 degrees, while maintaining uniform and consistent color and shape.

Part Number	Product Code	Lumen Transmission	Beam Angle	Max Deflection
AC-AM-0020-00-S1	03255	85%	13°	20°

Suggested method of use:

Use the orientation lines to adjust beam deflection angle.



Narrower angle between orientation lines results in more deflection

Wider angle between orientation lines results in lesser deflection

Stacked orientation lines will result in undesirable optical artifacts. Rotate one lens slightly to mitigate.

Note: May be used with Beam Spreader, Linear, and Flat Top SNAP accessory.

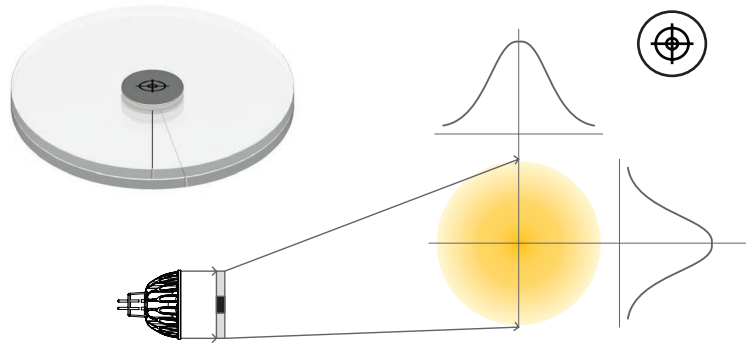

CCT SHIFTER SNAP

Use in hospitality and restaurant applications to simulate warm dimming. Create custom colors for festive occasions or brand identity. Single Lamp SKU can be used for multiple color temperatures

CTO*	Part Number	Product Code	Lumen Transmissivity	Mired Shift
1/4	AC-CC-0001-00-S1	00323	90%	37
1/2	AC-CC-0002-00-S1	00321	75%	83
3/4	AC-CC-0003-00-S1	00319	60%	120

*Color Temperature Orange
 Diameter: 50.0 mm Thickness: 2 mm
 Magnetic Attach Force: 0.45 lb-F

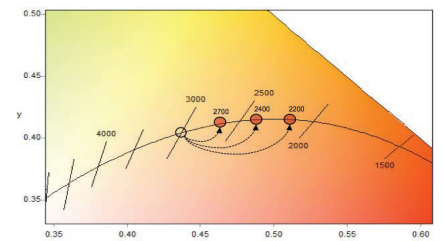

CCT SHIFT EFFECT

Starting Lamp CCT	1/4 CTO	CTO	1/2 CTO	3/4 CTO
2,700K	2,450K	2,200K	2,000K	
3,000K	2,700K	2,400K	2,200K	
4,000K	3,500K	3,000K	2,700K	

SORAA SNAP SYSTEM LED ACCESSORIES - SMALL (2")

CLEAR SNAP

Use together with gel and dichroic filters for total color freedom. Produce the exact mood and effect for any environment with the Clear SNAP accessory, Clear Snap are sold in quantities of ten.

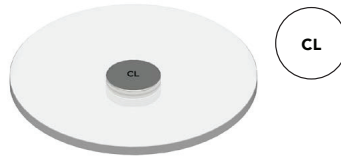

Suggested method of use for:

Gel Filter

Dichroic Filter

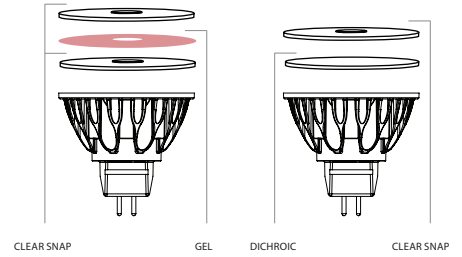

Part Number	Product Code	Lumen Transmissivity (1 Snap)	Lumen Transmissivity (2 Snaps)
AC-CL-0000-00-S1	02183	93%	87%

Diameter: 50.0 mm Thickness: 2 mm

Magnetic Attach Force: 0.45 lb-F

ENHANCE

Enhance is a unique color-enhancing filter. Designed to modify the spectrum of Soraa Vivid lamps, it increases the vividness of warm colors (including red, orange and pink colors) as well as greens. In applications where a more colorful setting is sought, Enhance lets the richness of colors stand out even more.

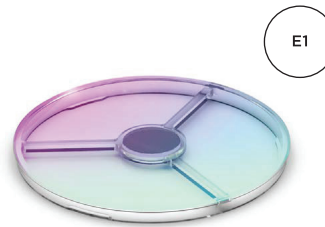

Part Number	Product Code	Lumen Transmissivity	Whiteness
AC-EN-0001-00-S1	03281	75%	130%

Diameter: 50.0 mm Thickness: 2 mm

Magnetic Attach Force: 0.20 lb-F

Application Notes:

Can be used in combination with any SORAA Vivid 10° lamp. Recommended use with CCTs of 3000K and 2700K

Recommend that the Enhance be combined with either a Louver Snap accessory (for 10° spot applications) or with a Beam Spreader Snap accessory (for other beam angles).

When stacking the Enhance Snap with other Snap accessories the Enhance Snap should be placed as the first filter on the lamp, followed by other Snaps.

SORAA VIVID

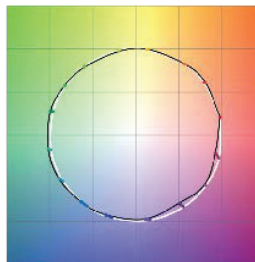

Rf:90, Rg:100

Rw (Whiteness): 120 (2700K & 3000K)

ENHANCE SNAP

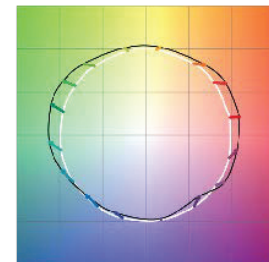

Rf:75, Rg:112

Rw (Whiteness): 130 (2700K & 3000K)