

HEADS – MONOPOINT MOUNT

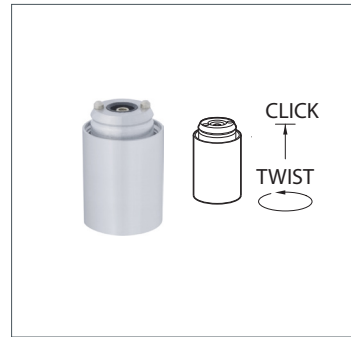

HEADS – MONOPOINT MOUNT – LED MR-16

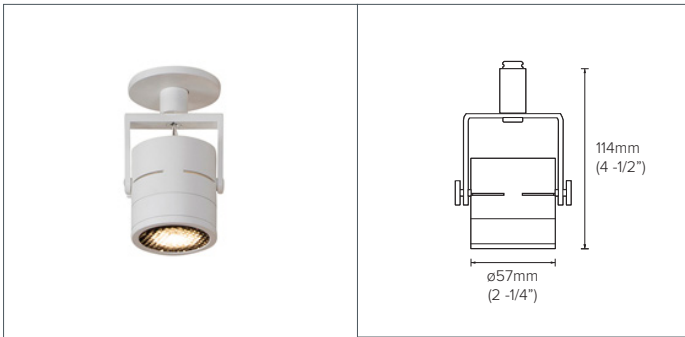

Claro Spot, Monopoint Mount, Aluminum, White, Black, Bronze, Brushed Brass or Polished Brass* Finish (CLARO-AL, WH, BLK, BRZ, BBR, PBR*)

The Claro MR-16 Spot combines design excellence with precision engineering. Claro features excellent beam control with the use of optional Media. Brushed Aluminum (AL), Black (BLK), White (WH), Oil-Rubbed Bronze (BRZ) or Brushed Brass (BBR) finish. *Contact factory for Polished Brass (PBR), special order with a minimum order of 25. Claro Spot has a modular design and is compatible with Remote Power or Integral Power Monopoints. Monopoints and Remote Power Supply(s) ordered separately to create a complete System.

Note: Claro Spot shown above installed into a Remote Power Monopoint, Flat Plate, ordered separately.

Click & Twist System

The Click & Twist connection design allows Spots to be easily removed. The Spot clicks into the jack plug socket, the threaded jacket then screws into position to lock the connection in place. Once installed, the Spot can be rotated vertically and horizontally to achieve the designed aim angle.

ACCESSORIES

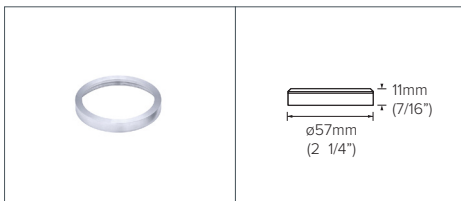

Media Holder 2, Aluminum, White, Black, Bronze or Brushed Brass Finish (MH2-16-AL, WH, BLK, BRZ, BBR)

Can accommodate up to two Media or a Snoot with one Media. Brushed Aluminum (AL), Black (BLK), White (WH), Oil-Rubbed Bronze (BRZ) or Brushed Brass (BBR) finish.

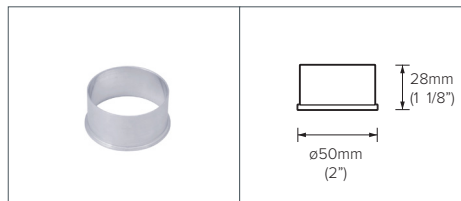

Snoot, Aluminum, White or Black Finish (SNT-16-AL, WH or BLK)

Provides glare control and reduces light spill. Can be installed into a standard Claro Spot, no Media. To install one Media and a Snoot, add the Media Holder 2 (MH2-16). Brushed Aluminum (AL), Black (BLK), White (WH) finish. Special order Oil-Rubbed Bronze (BRZ).

NOTE:

1. The Claro Snoot can be only used alone (no Media) with standard Claro Spot. A Snoot with one Media requires the addition of a Media Holder 2 (MH2-16). Contact factory for a solution when using the Snoot with 2 or 3 Media.

HEADS – MONOPOINT MOUNT

MEDIA ACCESSORIES

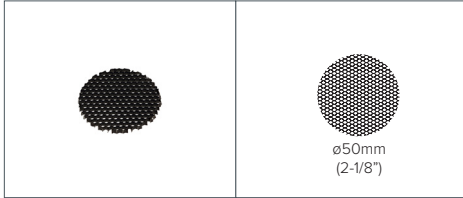

Honeycomb Louver 16 (HCL-16-BLK)
 1/8" Hexcell black metal. Controls spill illumination and glare.

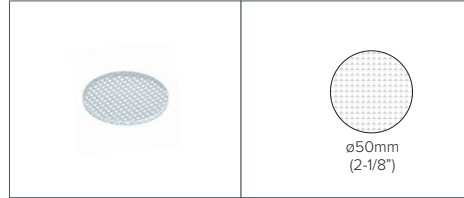

Prismatic Lens 16 (PL-16)
 Tempered low-iron glass. Creates a symmetrical broadening of the lamp beam.

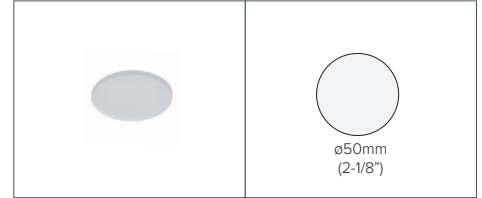

Sandblasted Lens 16 (SBL-16)
 Tempered low-iron glass. Creates a uniform beam pattern that is useful for wall washing.

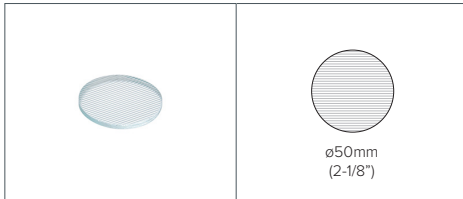

Linear Spread Lens 16 (LSL-16)
 Tempered low-iron glass. Will extend the lamp's beam along one axis to allow highlighting of wider areas from a single fixture.

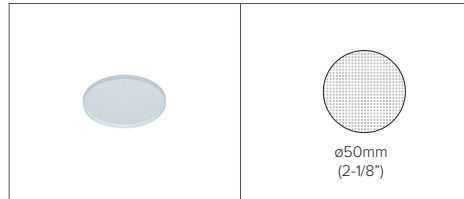

Softening Lens 16 (SFL-16)
 Tempered low-iron glass. Smooths and widens irregular beam pattern.

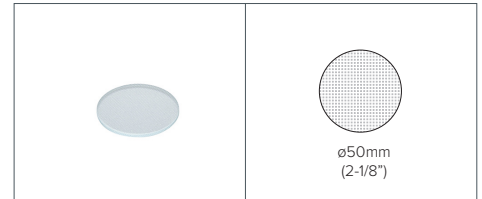

Solite Lens 16 (SOL-16)
 Tempered low-iron optically clear glass with a stipple effect that provides obscurity while retaining high transmission values and minimal absorption.

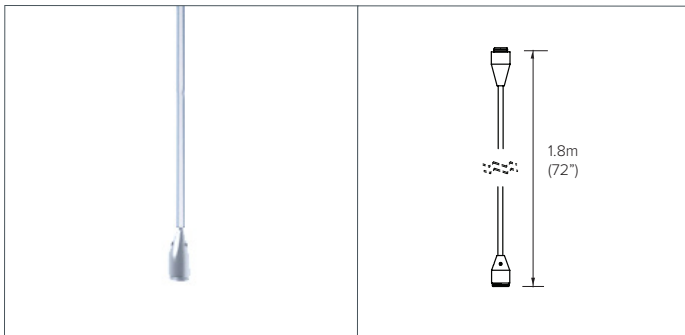

72" Spot Stem Extension, Aluminum, Black or White Finish (SPOT-EXT72-AL, BLK or WH)

Spot Stem Extension for use with Monopoints. Attaches to the Claro Spot for an extension up to 72". Spot Extensions can be shortened in the field or at the factory for an additional cost. **Note: A Sloped Ceiling Adapter must be added for use in Sloped Ceilings with Monopoints; refer to the Monopoint Specification Sheets under "Accessories" for details.** Refer to Installation Instructions for details. Contact the factory for a special order Double Spot Extension.

HEADS – MONOPOINT MOUNT

EXAMPLE SYSTEMS

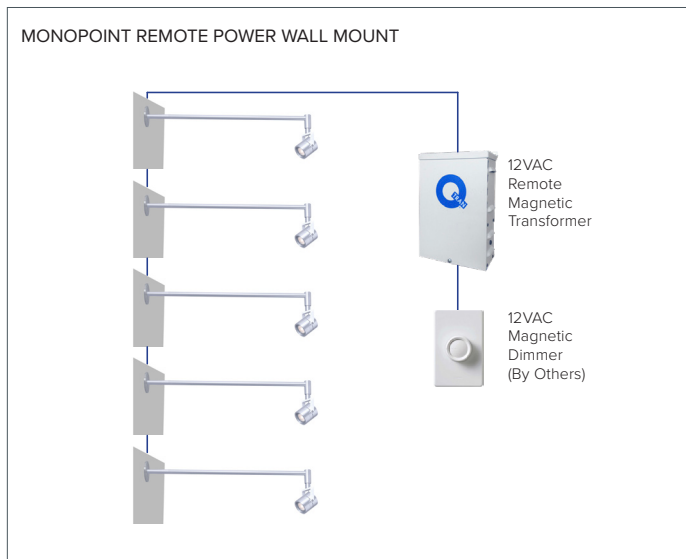
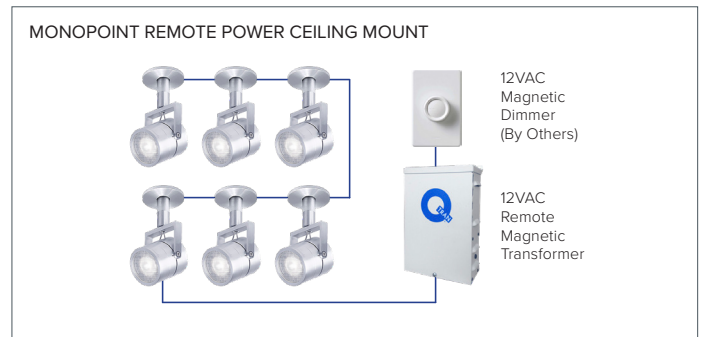
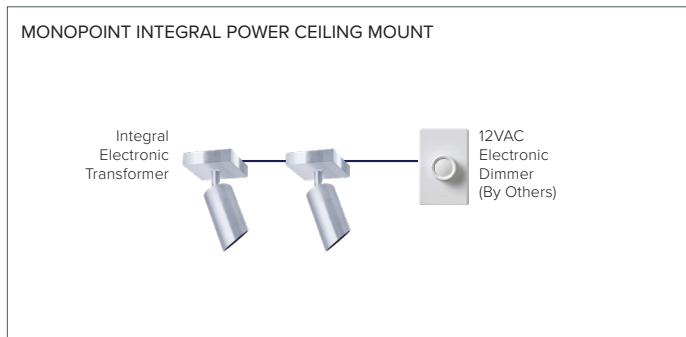

COMPATIBLE MONOPOINTS AND POWER SUPPLIES TO CREATE A COMPLETE SYSTEM

(Ordered separately, examples shown here)

[Monopoints and Power Supplies](#). Click this link to access the details below.



REMOTE POWER SUPPLIES

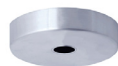

MONOPOINTS INTEGRAL POWER SUPPLY



MONOPOINTS REMOTE POWER SUPPLY

HEADS – MONOPOINT MOUNT



- Category:** Claro LED MR-16 Spot combines design excellence with precision engineering. Claro features excellent beam control with the use of variety of Accessories.
- Material:** Machined aluminum for aluminum, black, white finishes. Oil rubbed bronze and brass finishes are made of machined brass.
- Finish:** Brushed Aluminum (AL), Black (BK), White (WH), Oil-Rubbed Bronze (BRZ), Brushed Brass (BBR). Contact factory for Polished Brass (PBR) finish.
- System:** Monopoints and Power Supplies ordered separately to make a complete System. Claro Spot has a modular design and is compatible with Remote Power or Integral Power Monopoints.
- Adjustment:** Smooth, 360° bearing rotation with locking 90° vertical adjustment.
- Source:** Accommodates LED MR-16, 12VAC (GU5.3 Bi-Pin) lamp. Tegan can supply Soraa lamps. Note that all LED MR-16 lamps (Cree, Soraa, etc.) are rated for different operating conditions as per the lamp manufacturer. In addition, they are subject to frequent changes in recommended operating conditions and/or Spot compatibility. Please carefully check to ensure the lamp specified is rated to be compatible with the selected Tegan Spot. Contact factory to order LED lamps. For dimming LED MR-16 lamps (Soraa) with 12VAC transformers, please refer to the Power Supply Specs sheet.
- Installation:** Refer to Claro Installation Instructions for details.
- Accessories:** Media Holder 2-16 - can accommodate up to two Media (MH2-16) or One Media and One Snoot, Snoot (SNT), Honeycomb Louver 16 - Black (HCL-16-BLK), Prismatic Lens 16 (PL-16), Sandblasted Lens 16 (SBL-16), Linear Spread Lens 16 (LSL-16), Softening Lens 16 (SFL-16), Solite Lens 16 (SOL-16), 72" Spot Extension (SPOT-EXT72), 72" Double Spot Extension (DSPOT-EXT72) - Contact factory.
- Labels:** ETL & CE Listed; Tested to UL 1574 - Issue: 2004/09/07 Ed: 3 Rev:2012/01/25 UL Standard for Safety Spot Lighting Systems. IP20. Interior use only. In a continuing effort to offer the best product possible, we reserve the right to change, without notice, specifications or materials. Technical specification sheets that appear on teganlighting.com are the most recent version and supersede all other versions that exist in any other printed or electronic form. 3-Year Warranty.